



Heavy Duty/Off Highway

Life Sciences

Fluid Power

Industrial

Military

Mining

MRO

Pumps

Cylinders

Aerospace

Government

Transportation

Renewable Energy

PRODUCTS & CAPABILITIES



Engineered Solutions. Personal Support. Global Resources.



PSP Seals, LLC is a leading independent, engineering driven, stocking distributor specializing in customized sealing solutions. PSP provides products and services for Original Equipment Manufacturers (OEM) and Aftermarket in a wide variety of markets including the US Government/Military and Aerospace.

KITTING

As a leading supplier of sealing products and accessories we supply metric and inch versions of a vast array of sizes and materials in kit form. Customer provided items may also be included in the assembled kits.

- Reduced Cost
- Reduced Supply Chain
- Increased Profits
- Improved Part Availability
- Reduced Inventory
- Reduced Warehouse Space
- Complete Part Traceability

STOCKING SOLUTIONS/ WAREHOUSE

As a leading supplier of sealing products and accessories we supply metric and inch versions of a vast array of sizes and materials in kit form. Customer provided items may also be included in the assembled kits.

- Seal Selection
- Materials Selection
- Application Engineering
- Problem Solving
- Custom Seal Design & Development
- Failure & Value Analysis
- Supplier Finite Element Analysis

REVERSE ENGINEERING

As a leading supplier of sealing products and accessories we supply metric and inch versions of a vast array of sizes and materials in kit form. Customer provided items may also be included in the assembled kits.

- Seal Selection
- Materials Selection
- Application Engineering
- Problem Solving
- Custom Seal Design & Development
- Failure & Value Analysis
- Supplier Finite Element Analysis

CUSTOM LABELING

As a leading supplier of sealing products and accessories we supply metric and inch versions of a vast array of sizes and materials in kit form. Customer provided items may also be included in the assembled kits.

- Seal Selection
- Materials Selection
- Application Engineering
- Problem Solving
- Custom Seal Design & Development
- Failure & Value Analysis
- Supplier Finite Element Analysis

PACKAGING

As a leading supplier of sealing products and accessories we supply metric and inch versions of a vast array of sizes and materials in kit form. Customer provided items may also be included in the assembled kits.

- Seal Selection
- Materials Selection
- Application Engineering
- Problem Solving
- Custom Seal Design & Development
- Failure & Value Analysis
- Supplier Finite Element Analysis



PISTON SEALS

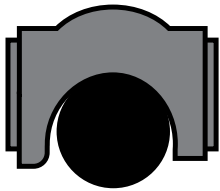

P-001



P-002



P-003

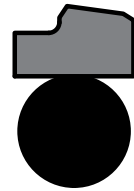

P-004

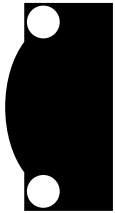

P-005

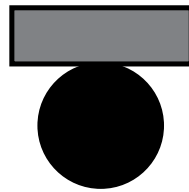

P-006



P-007

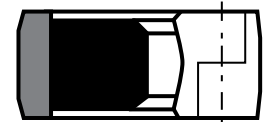

P-008

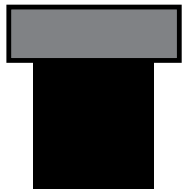

P-009

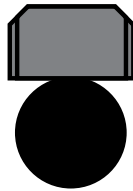

P-010

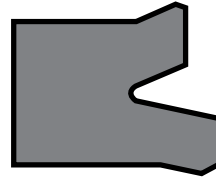

P-011

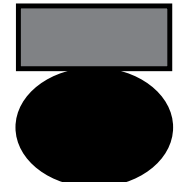

P-012

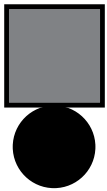

P-013

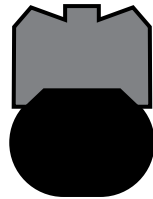

P-014

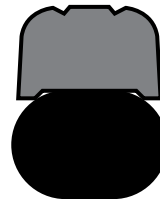

P-015

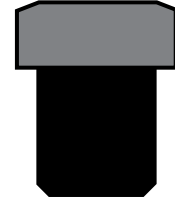

P-016

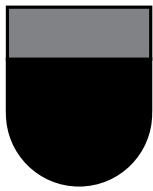

P-017

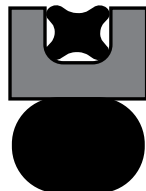

P-018

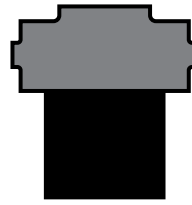

P-019

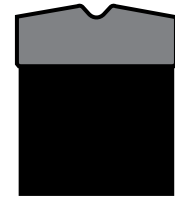

P-020



P-021

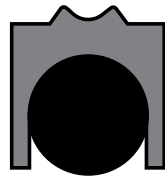

P-022



P-023

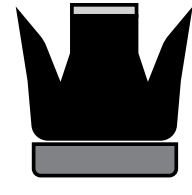

P-024

For more information, call: 260-436-7805

PISTON SEALS

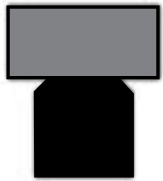

P-025



P-026



P-027



P-028



P-029

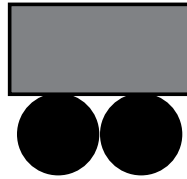

P-030



P-031



P-032



P-033

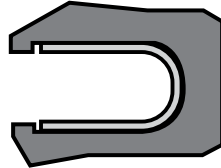

P-034

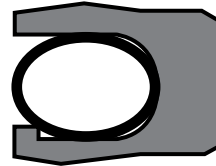

P-035

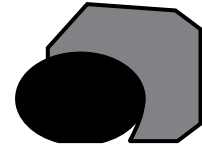

P-036



P-037



P-038



P-039



P-040



P-041



P-042



P-043



P-044



P-045



P-046



P-047

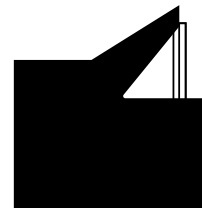

P-048

PISTON SEALS



P-049

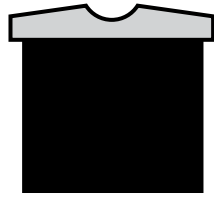

P-050

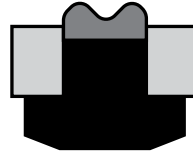

P-051

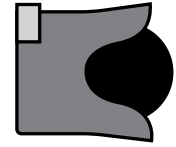

P-052



P-053

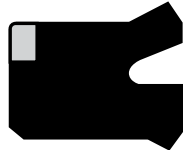

P-054

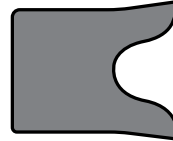

P-055

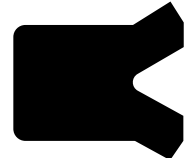

P-056



P-057

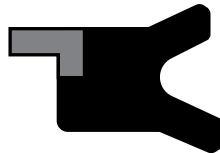

P-058

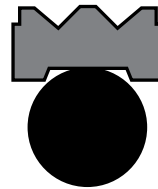

P-059

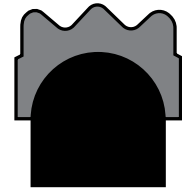

P-060

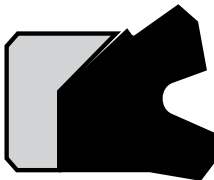

P-061

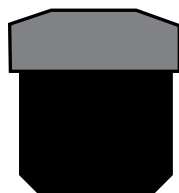

P-062

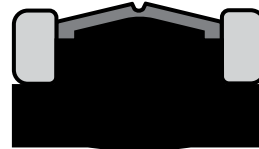

P-063

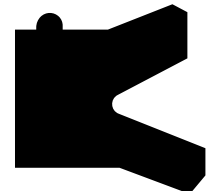

P-064

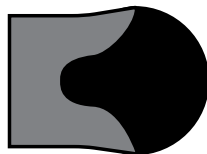

P-065

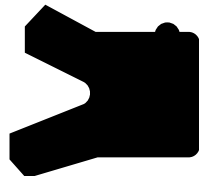

P-066



P-067

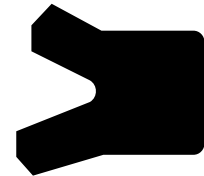

P-068



P-069

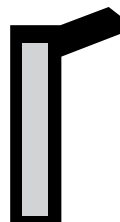

P-070



P-071

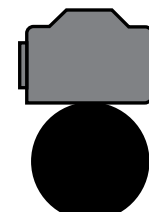

P-072

For more information, call: 260-436-7805

PISTON SEALS

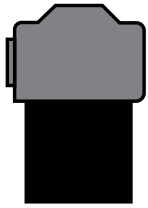

P-073

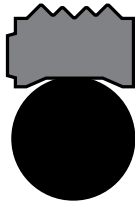

P-074



P-075



P-076

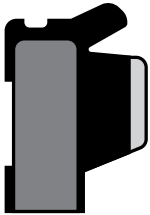

P-077

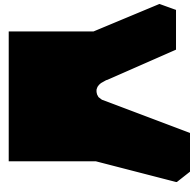

P-078

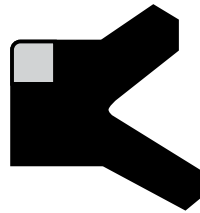

P-079

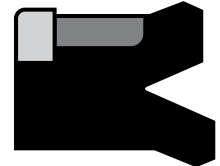

P-080

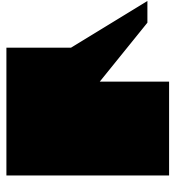

P-081



P-082

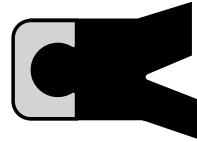

P-083



P-084



P-085

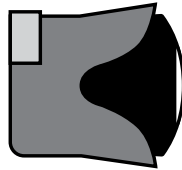

P-086

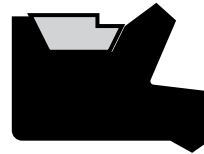

P-087

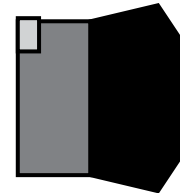

P-088

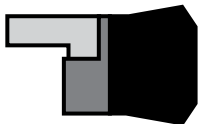

P-089



P-090

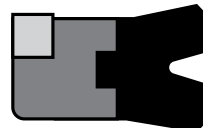

P-091

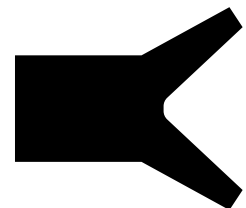

P-092



P-093



P-094

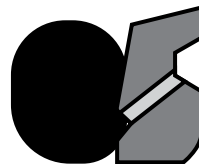

P-095



P-096

PISTON SEALS



P-097

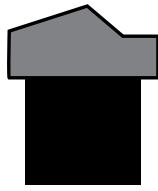

P-098



P-099



P-100

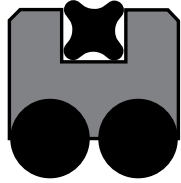

P-101



P-102



P-103



P-104



P-105



P-106



P-107



P-108



P-109



P-110



P-111



P-112



P-113



P-114



P-115



P-116



P-117



P-118



P-119



P-120

For more information, call: 260-436-7805

PISTON SEALS



P-121



P-122

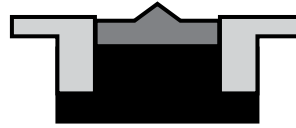

P-123



P-124



P-125



P-126



P-127



P-128



P-129



P-130



P-131

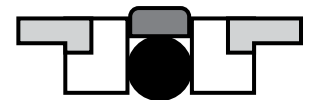

P-132

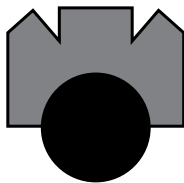

P-133

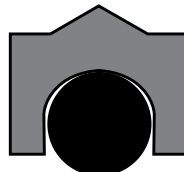

P-134



P-135



P-136



P-137



P-138



P-139



P-140

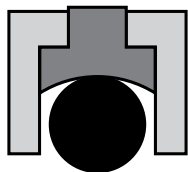

P-141

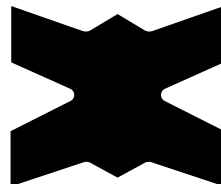

P-142

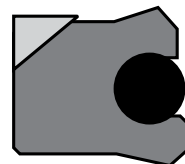

P-143

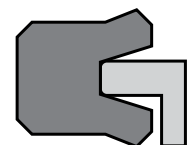

P-144

PISTON SEALS



P-145

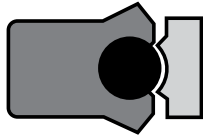

P-146



P-147

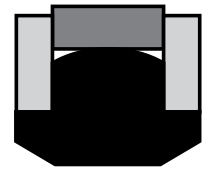

P-148



P-149

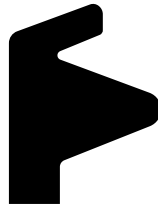

P-150

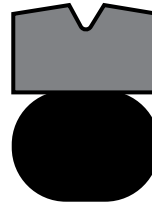

P-151

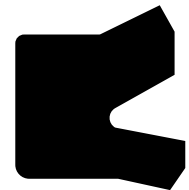

P-152

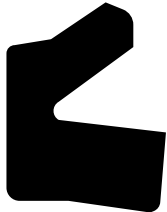

P-153

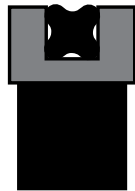

P-154

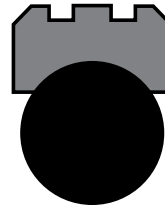

P-155

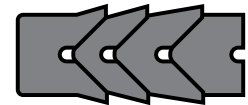

P-156

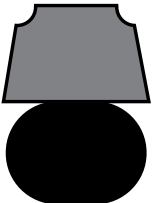

P-157

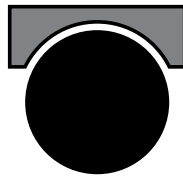

P-158

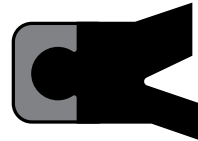

P-159



P-160



P-161



P-162

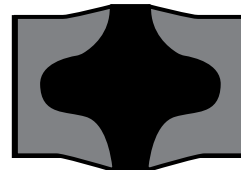

P-163



P-164

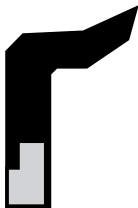

P-165

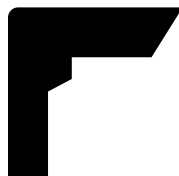

P-166



P-167

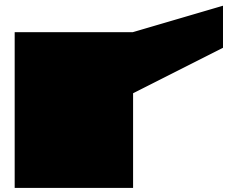

P-168

For more information, call: 260-436-7805

PISTON SEALS



P-169



P-170



P-171



P-172



P-173



P-174



P-175



P-176



P-177



P-178



P-179

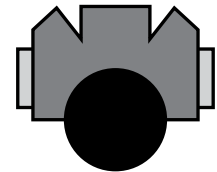

P-180

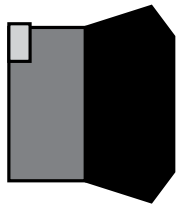

P-181



P-182

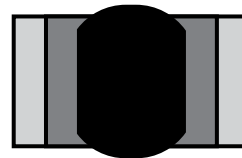

P-183



P-184



P-185



P-186

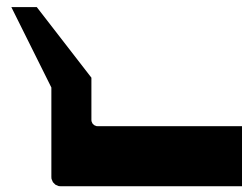

P-187

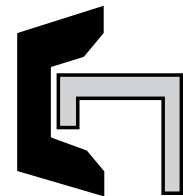

P-188



P-189

ROD SEALS

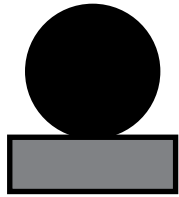

R-001

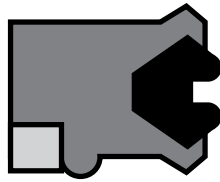

R-002



R-003

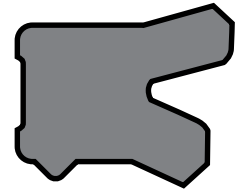

R-004

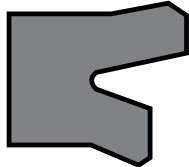

R-005



R-006

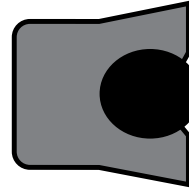

R-007

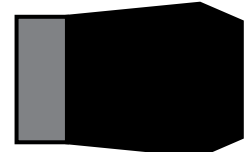

R-008



R-009

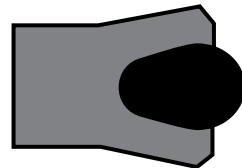

R-010



R-011



R-012



R-013

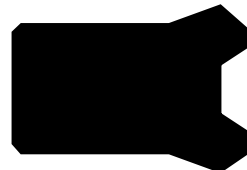

R-014

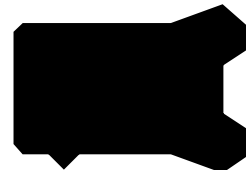

R-015



R-016

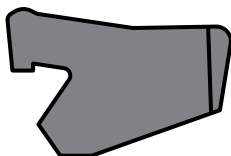

R-017

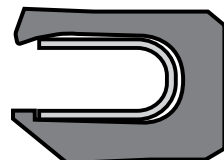

R-018

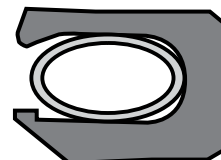

R-019

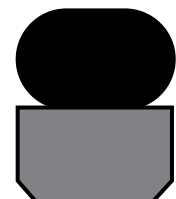

R-020

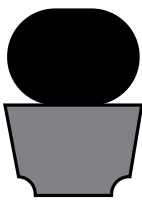

R-021

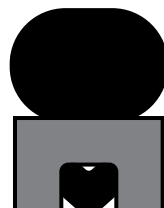

R-022

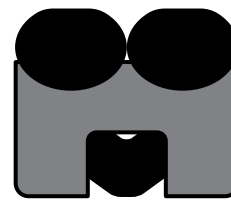

R-023

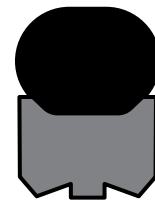

R-024

For more information, call: 260-436-7805

ROD SEALS

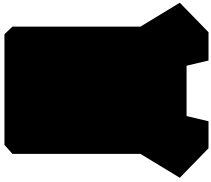

R-025

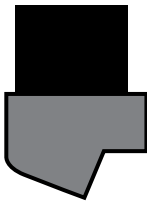

R-026



R-027

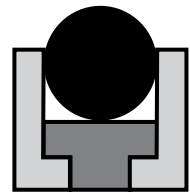

R-028

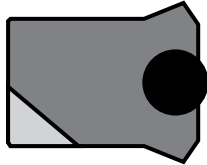

R-029



R-030

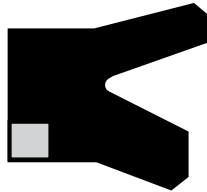

R-031



R-032



R-033

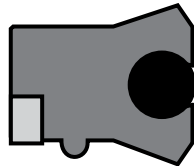

R-034

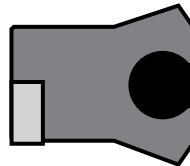

R-035

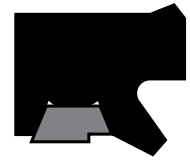

R-036



R-037

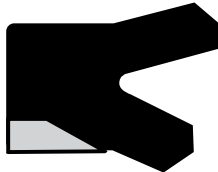

R-038



R-039

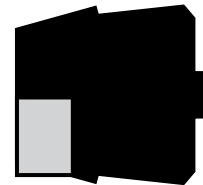

R-040

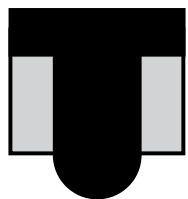

R-041



R-042



R-043

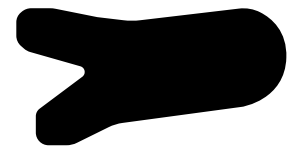

R-044



R-045

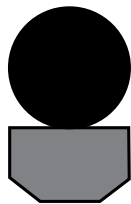

R-046

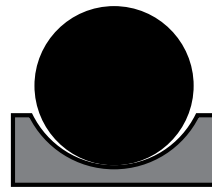

R-047

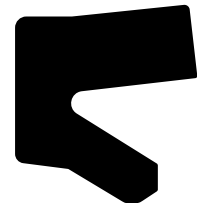

R-048

ROD SEALS

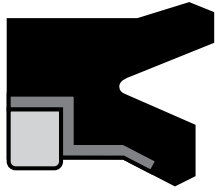

R-049



R-050

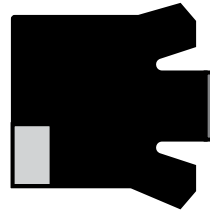

R-051



R-052

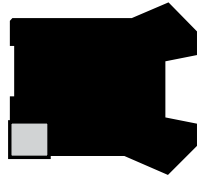

R-053



R-054



R-055

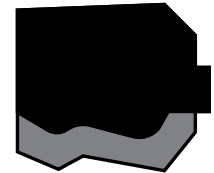

R-056

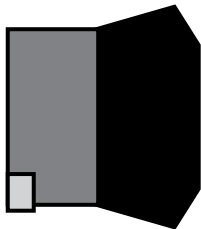

R-057

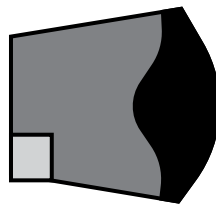

R-058



R-059

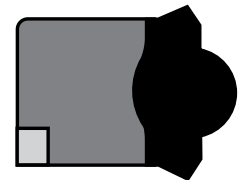

R-060



R-061



R-062

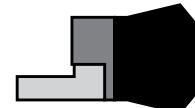

R-063



R-064

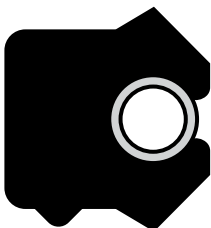

R-065

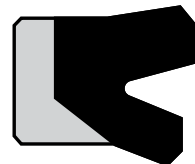

R-066



R-067

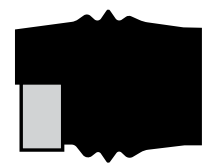

R-068



R-069

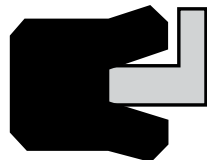

R-070

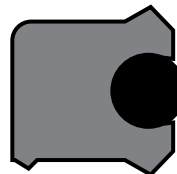

R-071



R-072

For more information, call: 260-436-7805

ROD SEALS



R-073

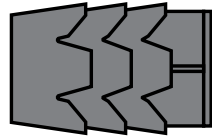

R-074



R-075

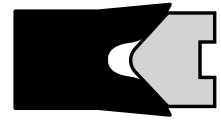

R-076



R-077

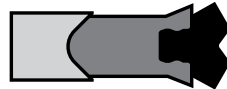

R-078



R-079



R-080

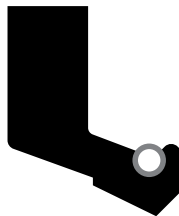

R-081

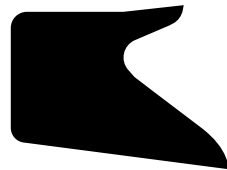

R-082



R-083

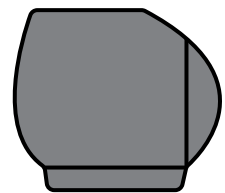

R-084

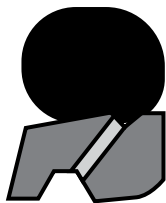

R-085

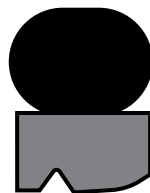

R-086



R-087

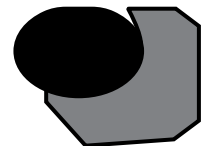

R-088

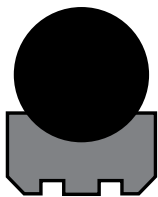

R-089

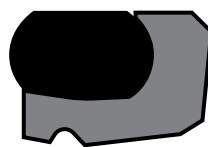

R-090



R-091

SYMMETRICAL SEALS

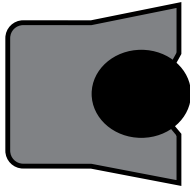

SY-001

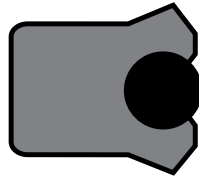

SY-002

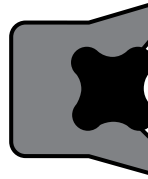

SY-003

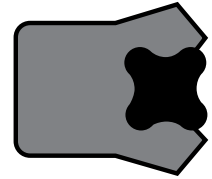

SY-004

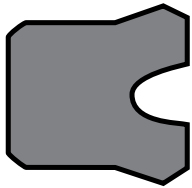

SY-005

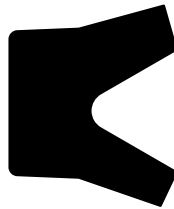

SY-006

WIPER SEALS

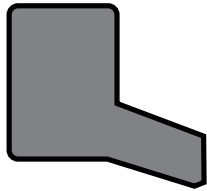

W-001

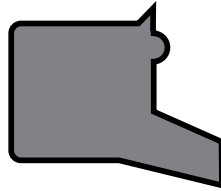

W-002

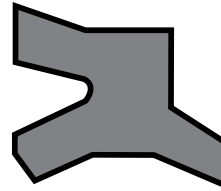

W-003

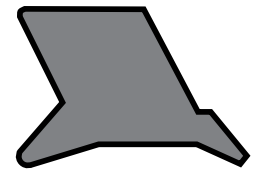

W-004

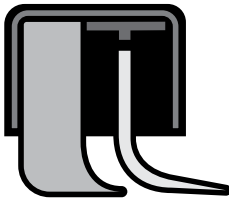

W-005

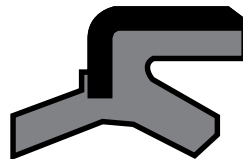

W-006

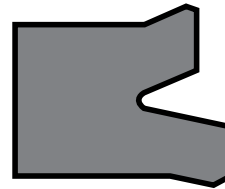

W-007



W-008

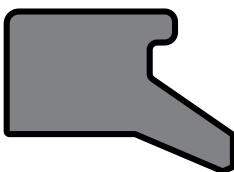

W-009

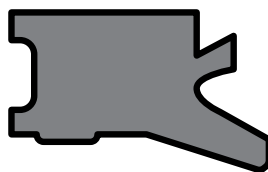

W-010

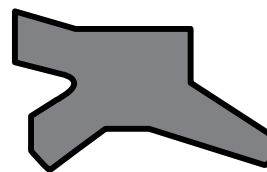

W-011

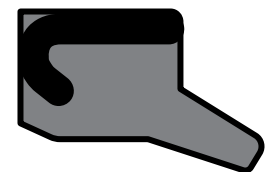

W-012

For more information, call: 260-436-7805

WIPER SEALS

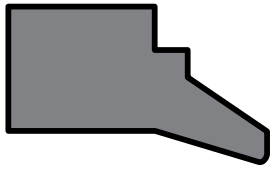

W-013

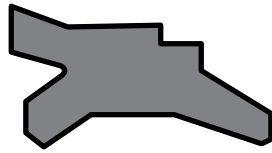

W-014

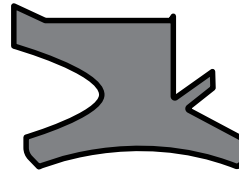

W-015

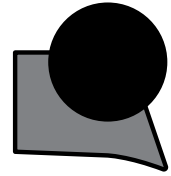

W-016

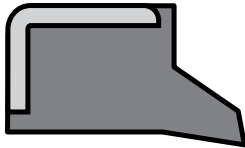

W-017

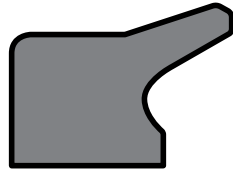

W-018

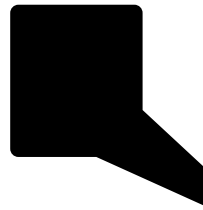

W-019

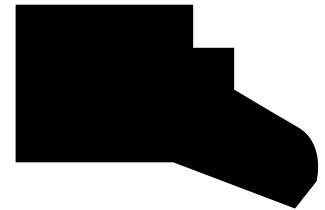

W-020



W-021

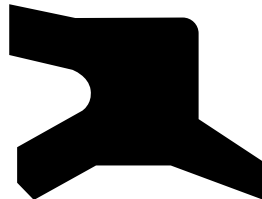

W-022

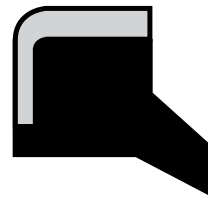

W-023

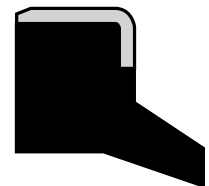

W-024

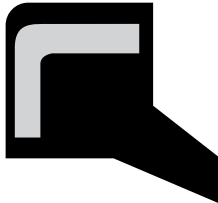

W-025

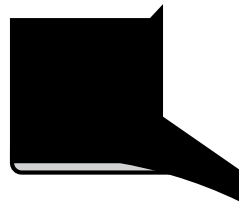

W-026

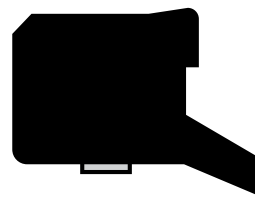

W-027

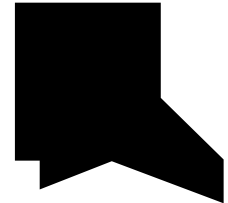

W-028



W-029

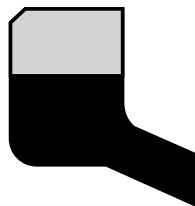

W-030

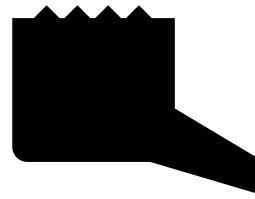

W-031



W-032

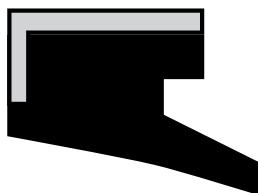

W-033

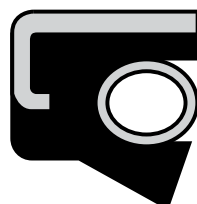

W-034

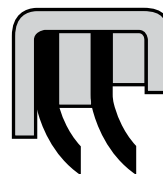

W-035

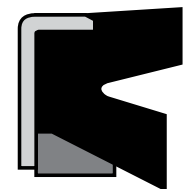

W-036

WIPER SEALS

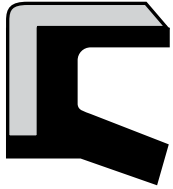

W-037

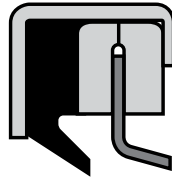

W-038

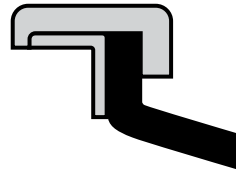

W-039

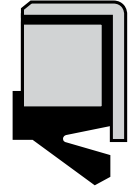

W-040

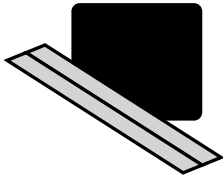

W-041

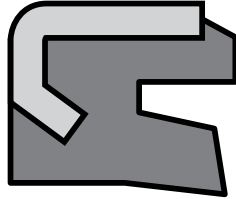

W-042

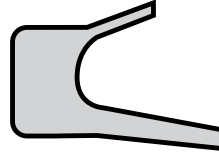

W-043



W-044

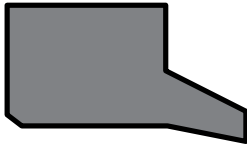

W-045

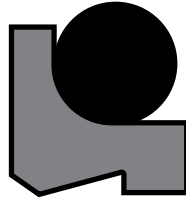

W-046

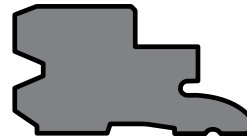

W-047

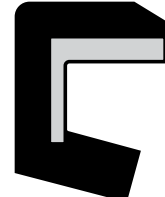

W-048

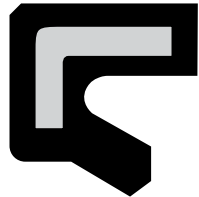

W-049



W-050



W-051

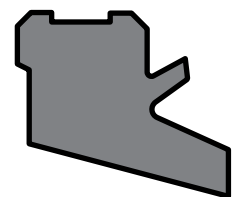

W-052

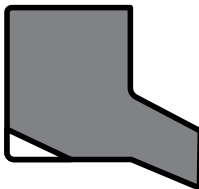

W-053

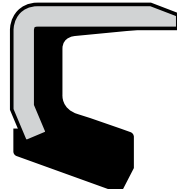

W-054

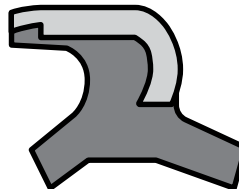

W-055

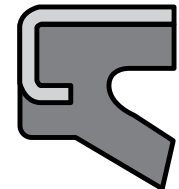

W-056

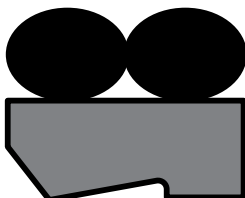

W-057

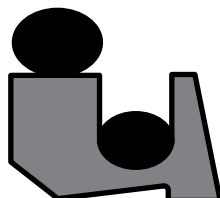

W-058

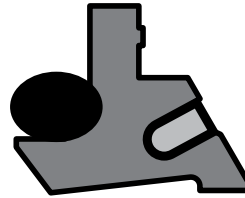

W-059

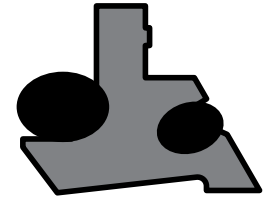

W-060

For more information, call: 260-436-7805

WIPER SEALS

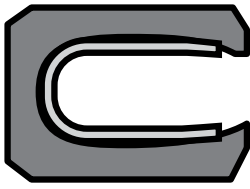

W-061

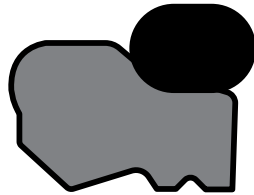

W-062

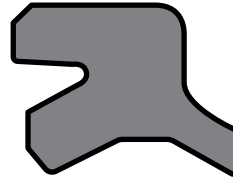

W-063

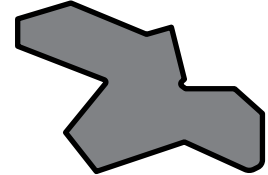

W-064

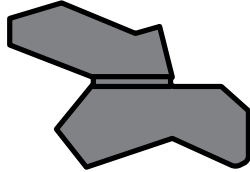

W-065

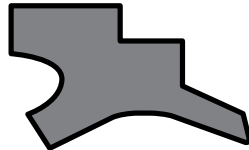

W-066

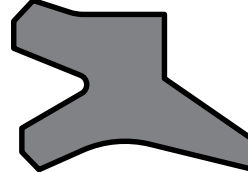

W-067

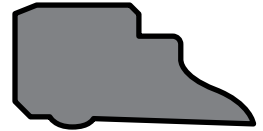

W-068

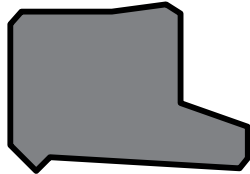

W-069



W-070

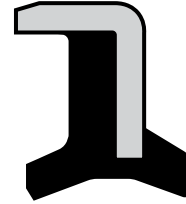

W-071

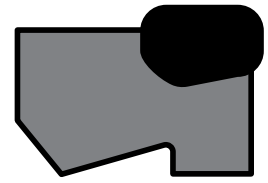

W-072

BUFFER SEALS

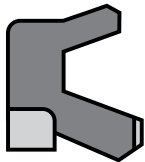

B-001



B-002



B-003

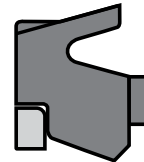

B-004

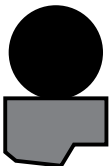

B-005

WEAR RINGS



WR-001



WR-002



WR-003



WR-004



WR-005



WR-006

STATIC SEALS



S-001

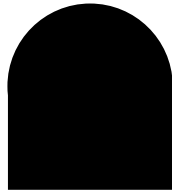

S-002

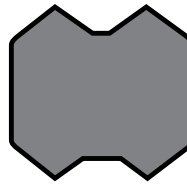

S-003

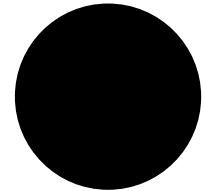

S-004

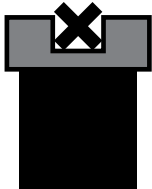

S-005

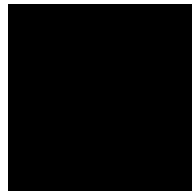

S-006

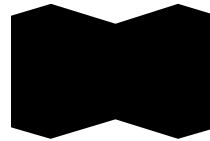

S-007

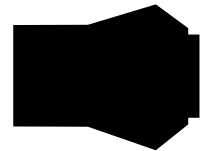

S-008



S-009



S-010



S-011



S-012

For more information, call: 260-436-7805

STATIC SEALS



S-013

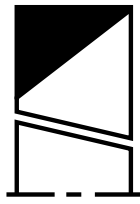

S-014



S-015



S-016

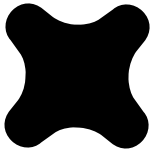

S-017



S-018



S-019

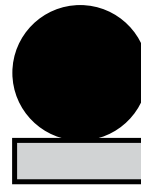

S-020

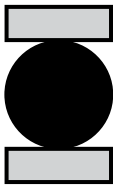

S-021



S-022



S-023



S-024



S-025

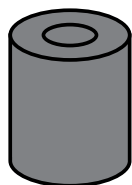

S-026



S-027

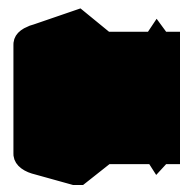

S-028

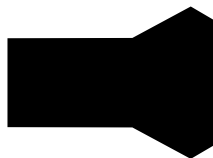

S-029

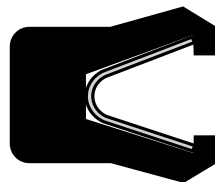

S-030



S-031

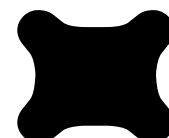

S-032



S-033

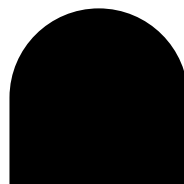

S-034

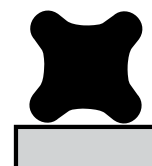

S-035

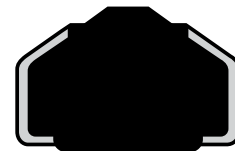

S-036

STATIC SEALS

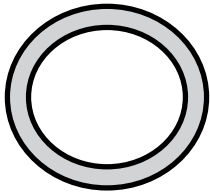

S-037

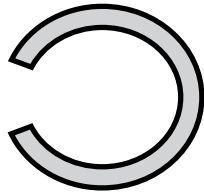

S-038

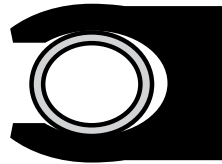

S-039

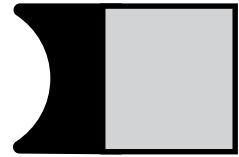

S-040

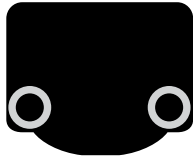

S-041

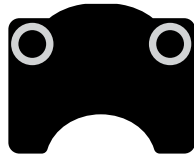

S-042

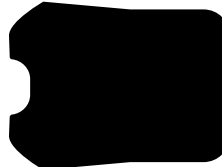

S-043

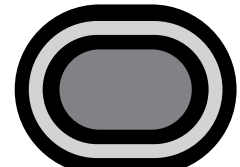

S-044



S-045



S-046

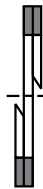

S-047

Rotary Seals

ROTARY SEALS



RS-001



RS-002



RS-003

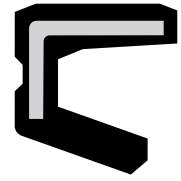

RS-004

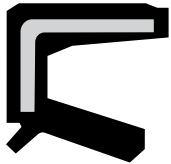

RS-005

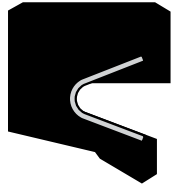

RS-006



RS-007



RS-008

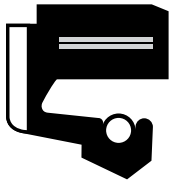

RS-009



RS-010



RS-011



RS-012



RS-013

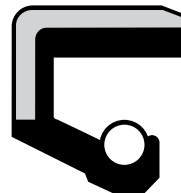

RS-014



RS-015

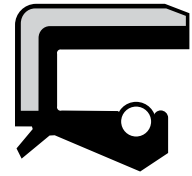

RS-016



RS-017

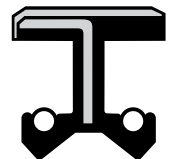

RS-018

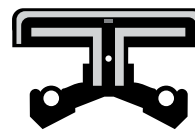

RS-019

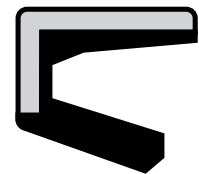

RS-020

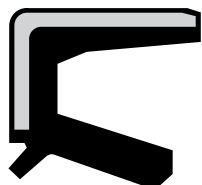

RS-021

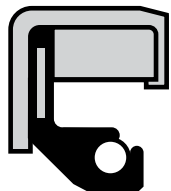

RS-022



RS-023

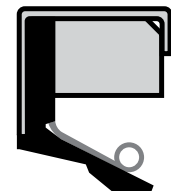

RS-024

Rotary Seals

ROTARY SEALS

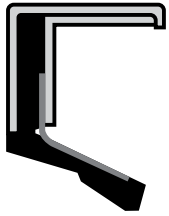

RS-025

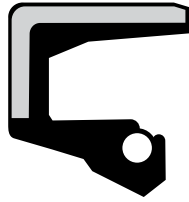

RS-026

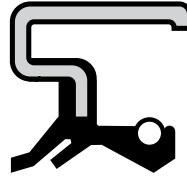

RS-027

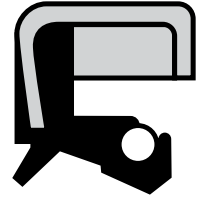

RS-028

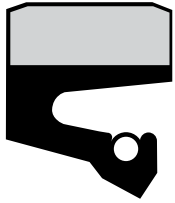

RS-029



RS-030

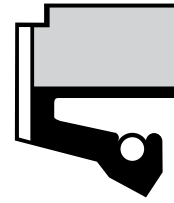

RS-031

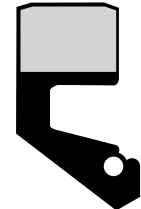

RS-032

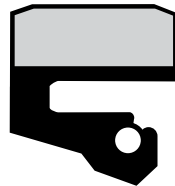

RS-033

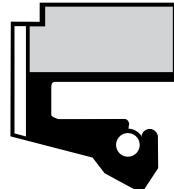

RS-034



RS-035



RS-036

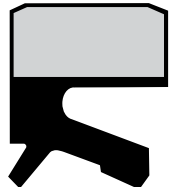

RS-037

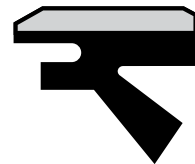

RS-038

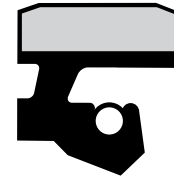

RS-039

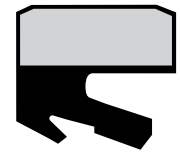

RS-040

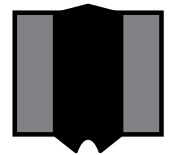

RS-041

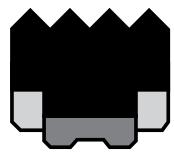

RS-042



RS-043

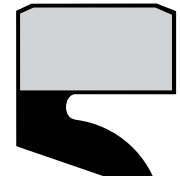

RS-044



RS-045

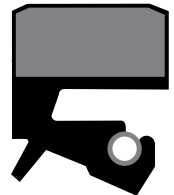

RS-046



RS-047



RS-048

For more information, call: 260-436-7805

Rotary Seals

ROTARY SEALS

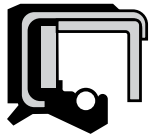

RS-049



RS-050

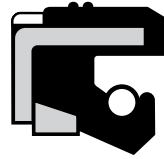

RS-051



RS-052



RS-053

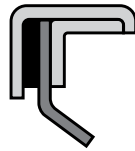

RS-054

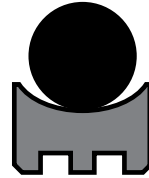

RS-055

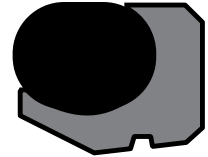

RS-056



RS-057

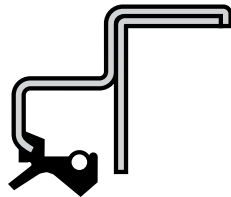

RS-058



RS-059



RS-060



RS-061

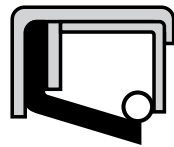

RS-062



RS-063



RS-064



RS-065

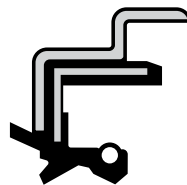

RS-066



RS-067

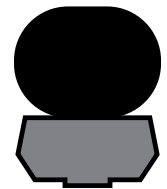

RS-068



RS-069



RS-070

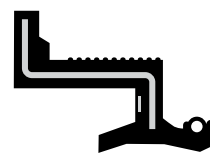

RS-071

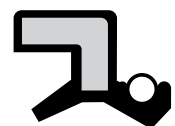

RS-072

Rotary Seals

ROTARY SEALS

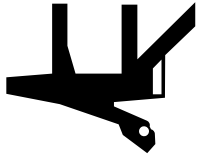

RS-073

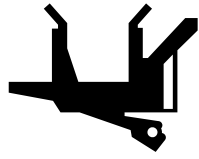

RS-074



RS-075



RS-076

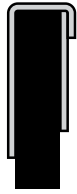

RS-077

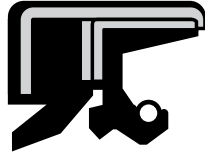

RS-078

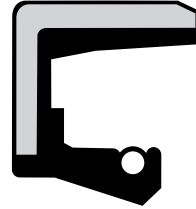

RS-079

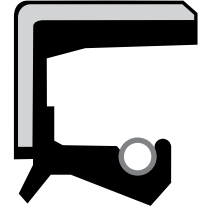

RS-080

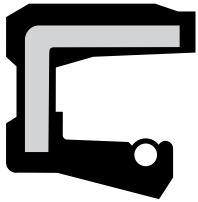

RS-081

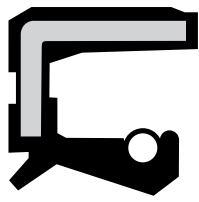

RS-082

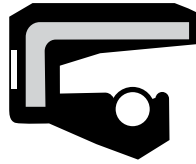

RS-083

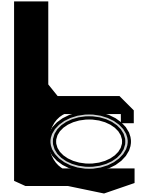

RS-084

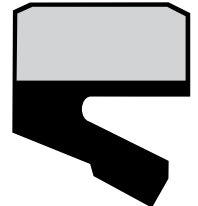

RS-085



RS-086

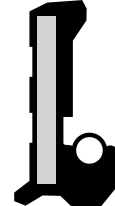

RS-087

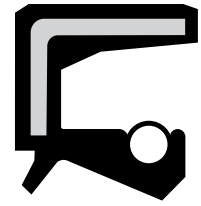

RS-088



RS-089



RS-090

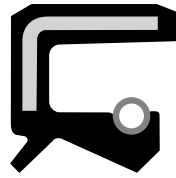

RS-091



RS-092



RS-093



RS-094

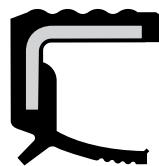

RS-095

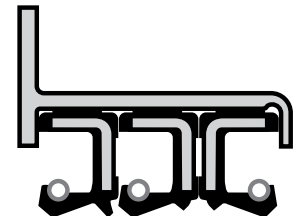

RS-096

For more information, call: 260-436-7805

Rotary Seals

ROTARY SEALS

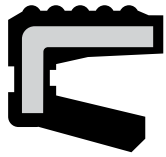

RS-097



RS-098

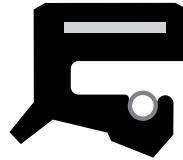

RS-099

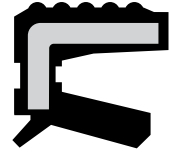

RS-100

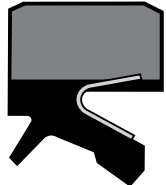

RS-101

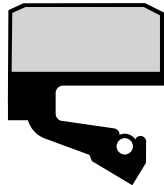

RS-102

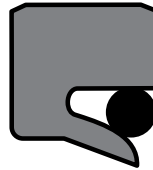

RS-103

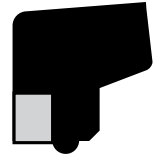

RS-104

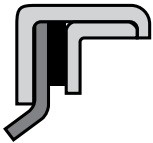

RS-105

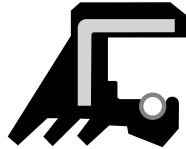

RS-106



RS-107

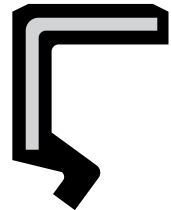

RS-108

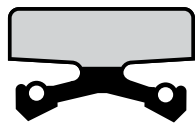

RS-109



RS-110



RS-111

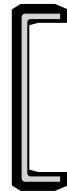

RS-112

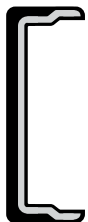

RS-113



RS-114

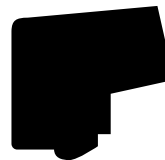

RS-115

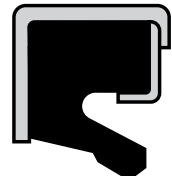

RS-116



RS-117



RS-118

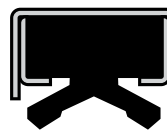

RS-119

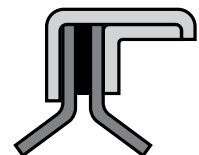

RS-120

Rotary Seals

ROTARY SEALS

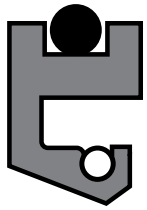

RS-121

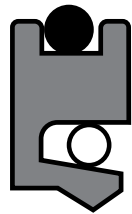

RS-122

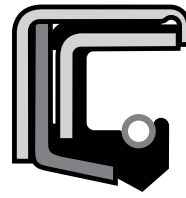

RS-123

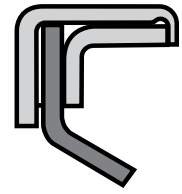

RS-124



RS-125

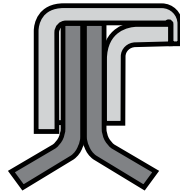

RS-126

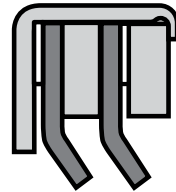

RS-127

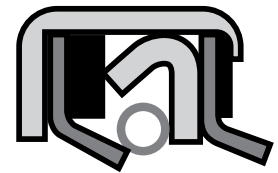

RS-128

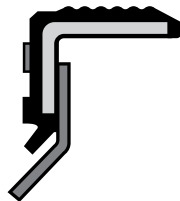

RS-129

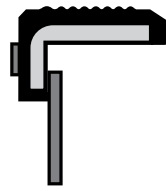

RS-130

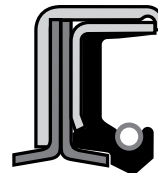

RS-131

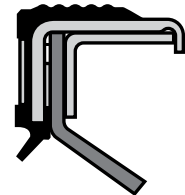

RS-132

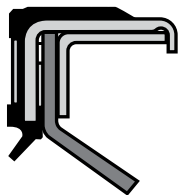

RS-133

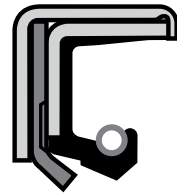

RS-134

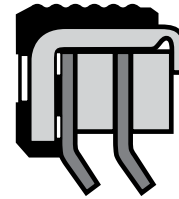

RS-135

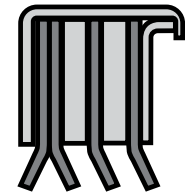

RS-136

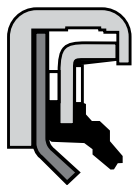

RS-137



RS-138

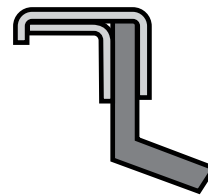

RS-139

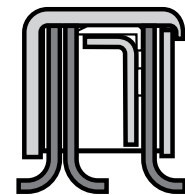

RS-140



RS-141



RS-142



RS-143



RS-144

For more information, call: 260-436-7805

Rotary Seals

ROTARY SEALS

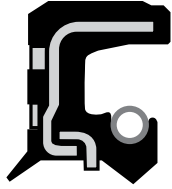

RS-145



RS-146



RS-147

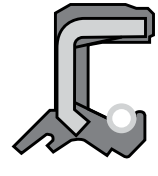

RS-148



RS-149



RS-150



RS-151



RS-152



RS-153



RS-154



RS-155



RS-156



RS-157



RS-158



RS-159



RS-160



RS-161



RS-162



RS-163



RS-164



RS-165

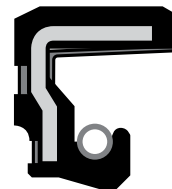

RS-166



RS-167

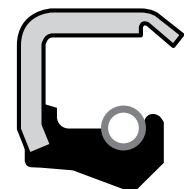

RS-168

Rotary Seals

ROTARY SEALS

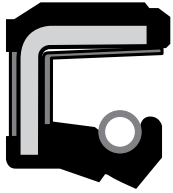

RS-169



RS-170



RS-171

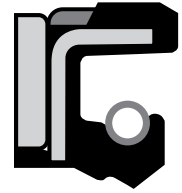

RS-172

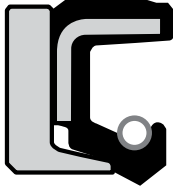

RS-173

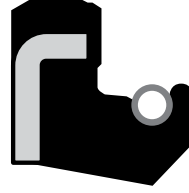

RS-174

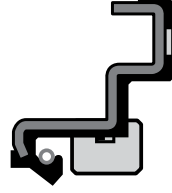

RS-175



RS-176

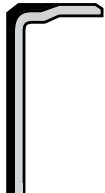

RS-177

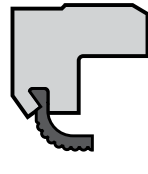

RS-178



RS-179

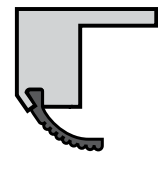

RS-180

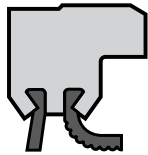

RS-181

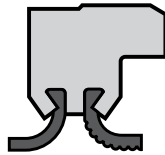

RS-182

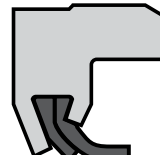

RS-183

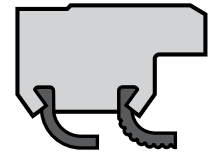

RS-184

CASE SEALS

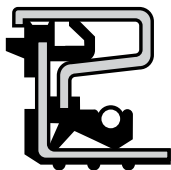

CS-001

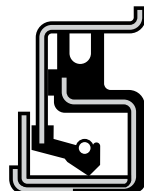

CS-002

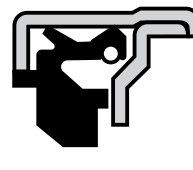

CS-003

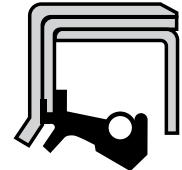

CS-004

For more information, call: 260-436-7805

Rotary Seals

CASE SEALS

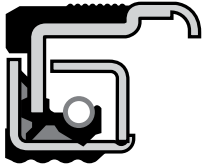

CS-005

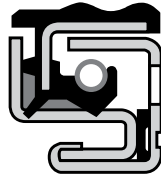

CS-006

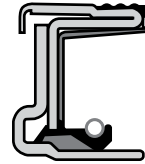

CS-007

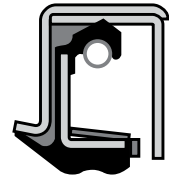

CS-008



CS-009

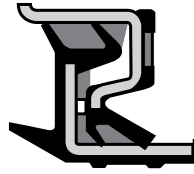

CS-010

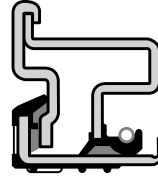

CS-011

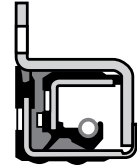

CS-012



CS-013

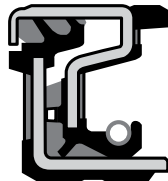

CS-014

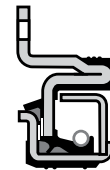

CS-015

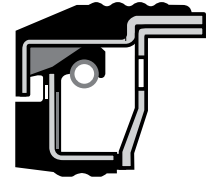

CS-016

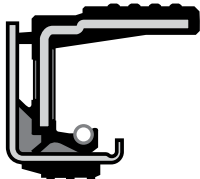

CS-017

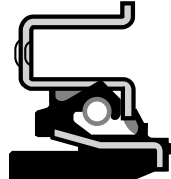

CS-018

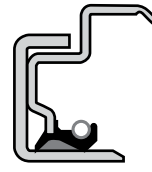

CS-019



CS-020

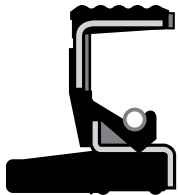

CS-021

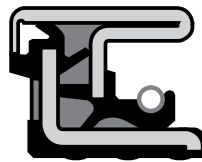

CS-022

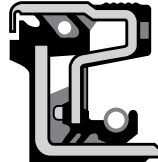

CS-023



CS-024

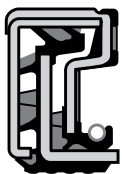

CS-025

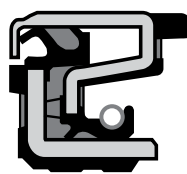

CS-026

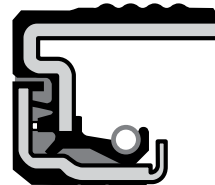

CS-027

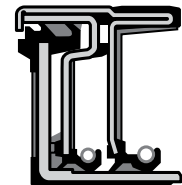

CS-028

Rotary Seals

CASE SEALS

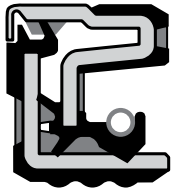

CS-029

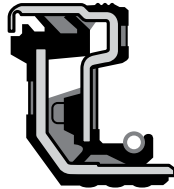

CS-030

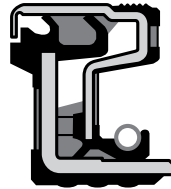

CS-031



CS-032

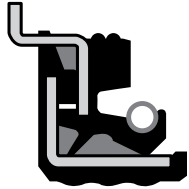

CS-033

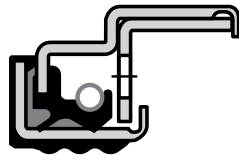

CS-034

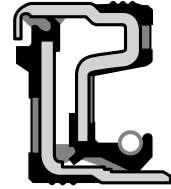

CS-035

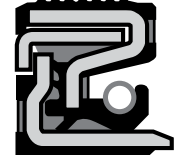

CS-036

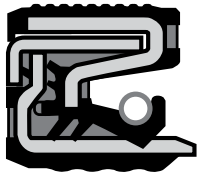

CS-037

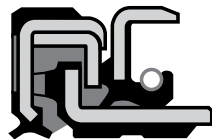

CS-038

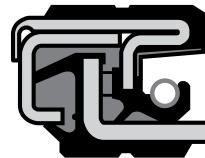

CS-039

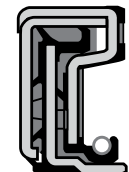

CS-040

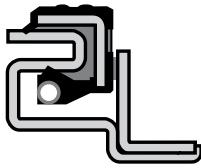

CS-041

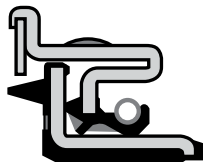

CS-042

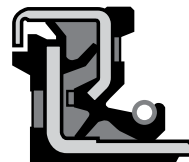

CS-043

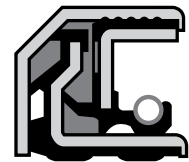

CS-044

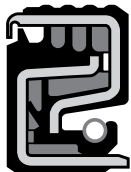

CS-045

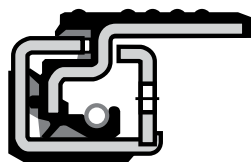

CS-046

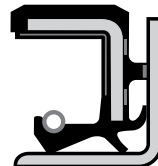

CS-047

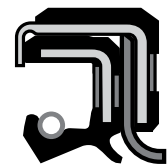

CS-048

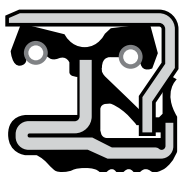

CS-049



CS-050

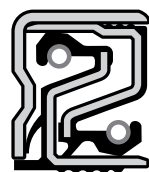

CS-051



CS-052

For more information, call: 260-436-7805

Rotary Seals

OIL SEALS

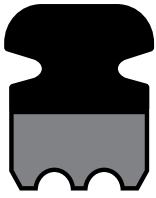

OS-001

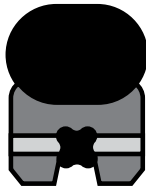

OS-002

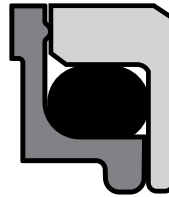

OS-003

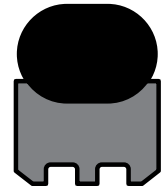

OS-004

V-RINGS



V-001



V-002



V-003



V-004



V-005



V-006



V-007



V-008

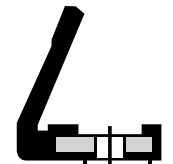

V-009

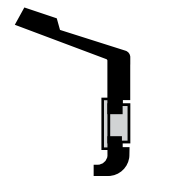

V-010

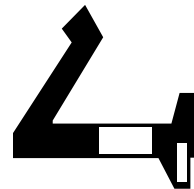

V-011



V-012



V-013



V-014



V-015

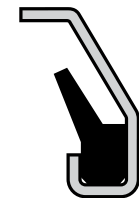

V-016

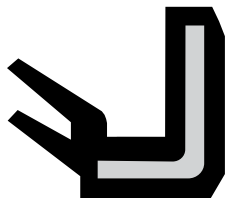

V-017

Accessories

VIBRA-TITE®



MEASURING TOOLS

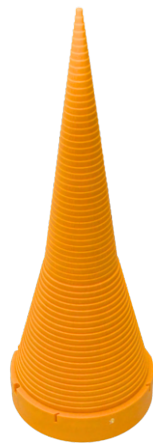

EXTRACTION TOOLS



INSTALLATION TOOLS

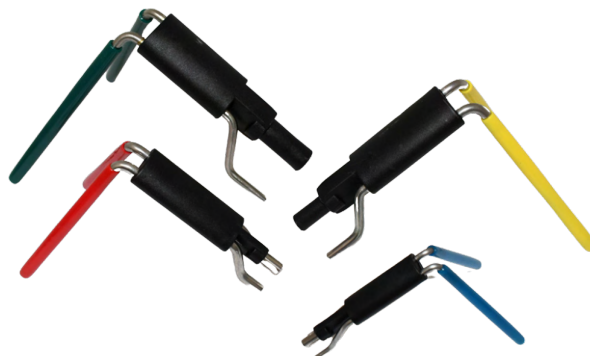

For more information, call: 260-436-7805

GASKETS

At PSP Seals, we understand the critical role gaskets play in ensuring the integrity and reliability of your engineering projects. Whether you're working with high-temperature environments, corrosive substances, or extreme pressure differentials, our extensive range of precision-engineered gaskets is designed to meet your exacting standards.

From knife cut and water jet to custom molding and stamping, PSP Seals can provide gaskets in various designs and sizes. Our team is ready to get the gaskets that get your production back on track and aid in engineering design. With decades of experience and a commitment to quality, we provide tailored solutions that fit your specific application needs, ensuring optimal performance and longevity. Call today to learn more!

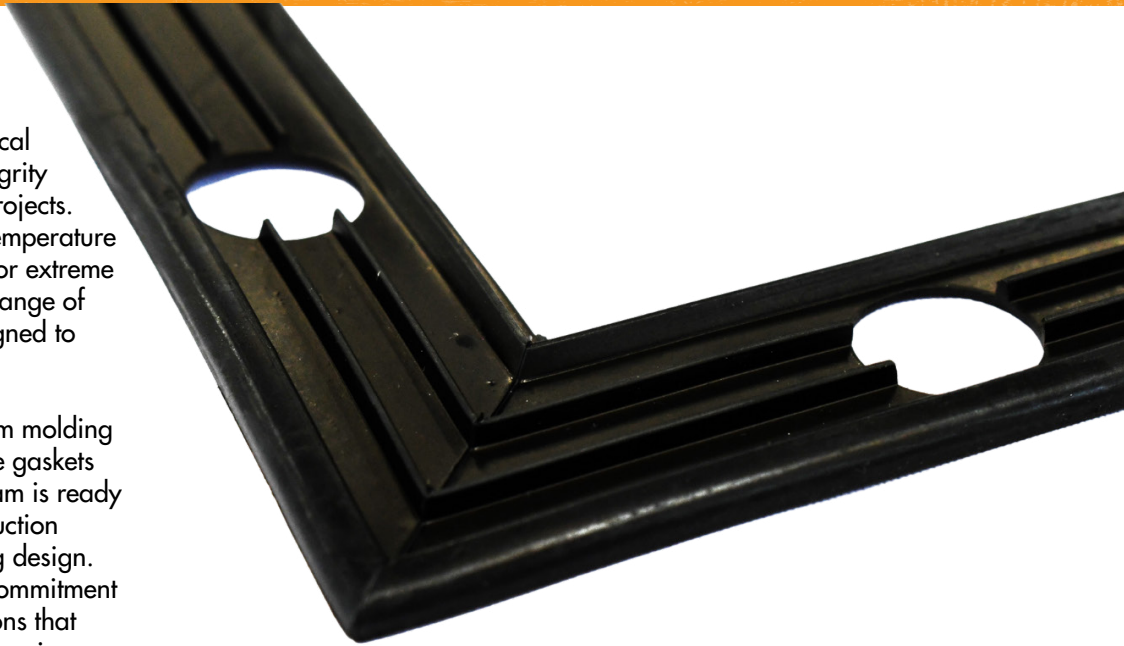

METAL-BONDED & THREAD SEALS

Designed to withstand extreme pressures, temperatures, and aggressive media, metal-bonded seals offer unmatched reliability for demanding applications. Leveraging advanced materials and state-of-the-art bonding techniques, metal-bonded seals and thread seals are engineered to provide superior sealing performance, even in the harshest environments. Both metal-bonded seals and thread seals are designed to secure parts of your system together combining the strength of a metal compound with the flexibility of a seal.

Our expert team of engineers and sealing professionals collaborate with you directly to deliver customized solutions that meet the exact specifications of your project. With a focus on precision and quality, PSP Seals ensures that our metal-bonded seals and thread seals keep your operations efficient and secure.

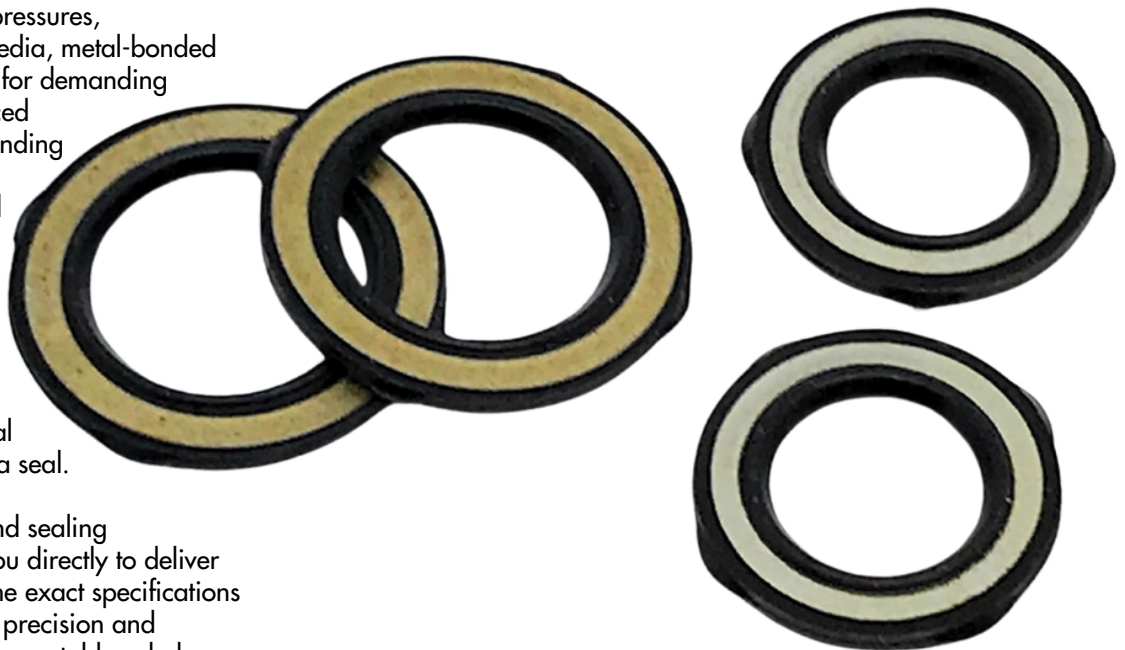

PNEUMATIC SEALS

Along with hydraulic seals, we also specialize in providing high-performance pneumatic seals that are essential for the efficient and reliable operation of your pneumatic systems. Designed to prevent leakage and ensure optimal pressure control, our pneumatic seals are engineered to withstand the demands of various industrial applications. With a comprehensive range of materials and designs, we tailor our seals to meet the unique requirements of your specific project. Our experienced team works closely with engineers and purchasing professionals to deliver solutions that enhance the longevity and efficiency of your systems. Trust PSP Seals to supply pneumatic seals that maintain the integrity of your operations, even in the most challenging environments.



For more information, call: 260-436-7805

Engineering Services



PSP Seal's in-house, experienced engineers create innovative and effective solutions to the most perplexing sealing problems. Our material expertise includes various rubber compounds, Polyurethane, PTFE compounds and engineered plastics.

- Seal & Gasket Selection
- Material Specification
- Material Testing
- Application Engineering Support
- Problem Solving
- Custom Seal Design & Development
- Failure Analysis
- Value Analysis
- Finite Element Analysis
- Product Validation Testing
- Reverse Engineering
- Non-Contact Measurement (Keyence)
- Computer Aided Design Modeling
- On-Site Trouble Shooting & Support
- Packaging & Label Support
- First Article Inspection
- PPAP

Additionally, as a top authorized distributor for Parker Engineered Materials Group and others, their engineers are readily available to assist us and our customers to develop new materials and products for new applications.

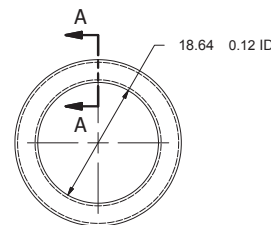
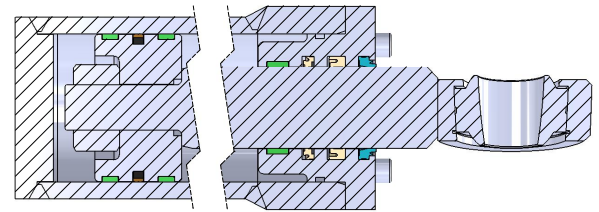

NOTES:
1.) ALL DIMENSIONS ARE IN MILLIMETERS
2.) MATERIAL: PUHP94 POLYURETHANE

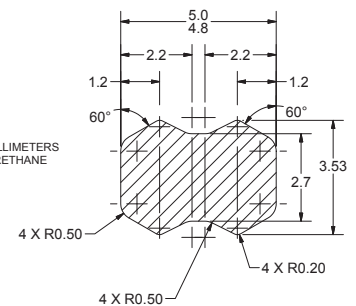

SECTION A-A

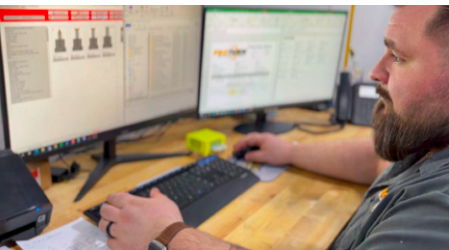

If you're looking for a unique seal profile or size or you are in a hurry to get your equipment back up and running, PSP Seals' custom-machined seal products are the solution. Order only what you need and when you need it.

PSP Seals offers in-house custom machining by ProTurn. Choose your material and seal profile and receive your fully customized seals with zero lead time available. All seals are checked for tolerance and quality throughout the machining process so you can rest assured that the seals you get meet and exceed industry standards.

A wide range of seal profiles are available including wipers, rod seals, piston seals, rotary, O-rings, wear rings, back-up rings, and custom profiles.

Available Materials:

- Hydrolysis-Resistant Polyurethane (HPU)
- CAST Hydrolysis-Resistant Polyurethane (C-HPU)
- PPDI
- NBR
- FKM
- PTFE Virgin
- PTFE GL-MOLY (15% Glass/5% Moly)
- PTFE CF (10% Carbon Fiber)
- PTFE CGT (23% Carbon/2% Graphite)
- PTFE BR-MOLY (40% Bronze/3% Moly)

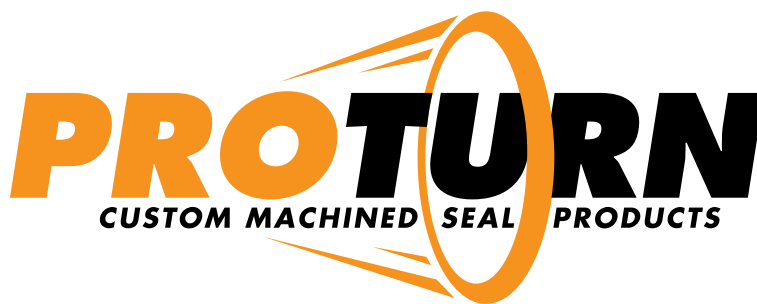

For more information, call: 260-436-7805

PSP Seals, LLC is a leading independent stocking distributor in customized sealing solutions with an engineering focus, personal support and global resources. PSP Seals Government Group serves as a conduit for the sale of seals, gaskets, o-rings and kits to the US Government via the Defense Logistics Agency (DLA), direct to the Armed Services and serving as a subcontractor to prime contractors.

Cage Code: 1SA02
JCP Certification #: 0072150
DUNS: 874771764
UEI: JYE7GZBALYH7
ISO 9001:2015
Small Business

PRODUCTS

Specializing in fluid power and hydraulic cylinder seals, metric and inch, including a vast array of sizes and material configurations.

- Piston Seals
- Symmetric Seals
- Rod Seals
- Buffer Seals
- Wiper Seals
- Wear Rings
- Static Seals
- EMI Shielding Gaskets
- Head Seals
- Gaskets
- Rotary Seals
- Pneumatic Seals
- Mechanical Seals
- Seal Kits
- Custom Seals

GLOBAL RESOURCES

PSP Seals has developed a proven network of world-class suppliers meeting our stringent quality and on-time delivery requirements including:



FREUDENBERG-NOK
INNOVATING TOGETHER



Visit: **PSPseals.com**

SERVICES

- Kitting (more than seals)
- Traceability
- MIL-STD-2073 & ASTM D 3951 Packaging
- Custom Packaging
- MIL-STD-129 Bar Coding
- Bar Coding
- Radio-Frequency Identification (RFID)
- Stocking Programs
- Managed Inventory Programs
- Technical Support Team
- Engineering Support
- Long Term Contract Support

ENGINEERING

Our experienced engineers create innovative solutions to the most perplexing sealing problems.

- Seal & Gasket Selection
- Material Specification
- Material Testing
- Application Engineering Support
- Problem Solving
- Custom Seal Design & Development
- Failure Analysis
- Value Analysis
- Finite Element Analysis
- Product Validation Testing
- Reverse Engineering
- Non-Contact Measurement (Keyence)
- Computer Aided Design Modeling
- On-Site Trouble Shooting & Support
- Packaging & Label Support
- First Article Inspection
- PPAP

PERSONAL SUPPORT

At PSP Seals, we listen closely to your needs and provide simple yet innovative and cost-effective solutions. Our customer service, technical support, engineering, and warehouse capabilities are centrally located in Fort Wayne, IN to fulfill your sealing requirements. Our ISO 9001:2015 certification provides a basis for our continual improvement in service and support.



A wholesale distributor since 2000, PSP Seals (ISO 9001:2015) is an engineering driven, stocking distributor specializing in customized sealing solutions including kitting & packaging.



INBOUND & OUTBOUND

At PSP Seals, we listen closely to your needs and provide simple yet innovative and cost-effective solutions. Multiple manufacturing resources are located in the United States and throughout Asia with quick lead times. Our customer service, technical support, engineering, and warehouse capabilities are centrally located in Fort Wayne, IN for fast shipping.



For more information, call: 260-436-7805

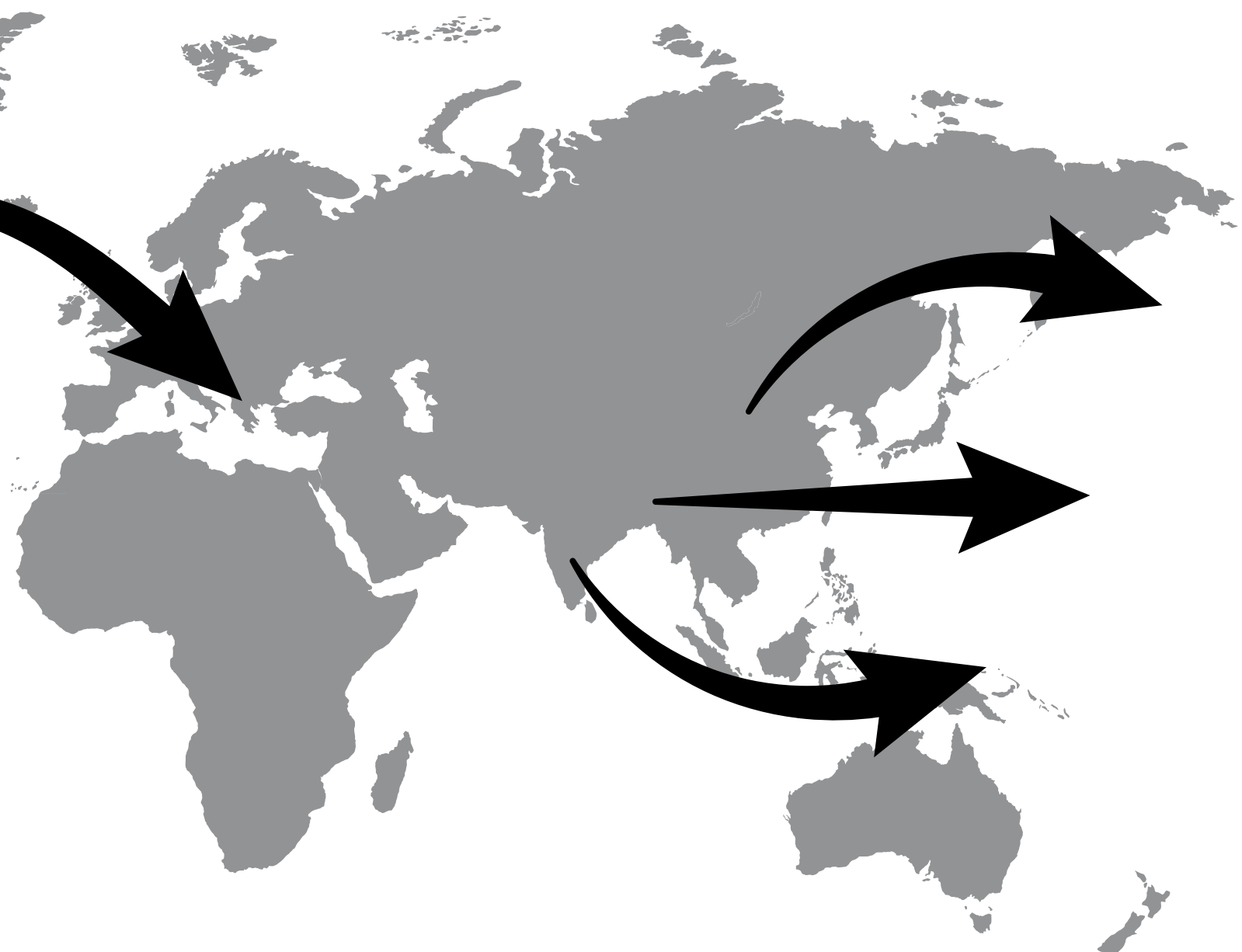



PSP Seals, LLC
3702 Vanguard Dr., Fort Wayne, IN 46809
260-436-7805
PSPseals.com